

Trace and write the letters.

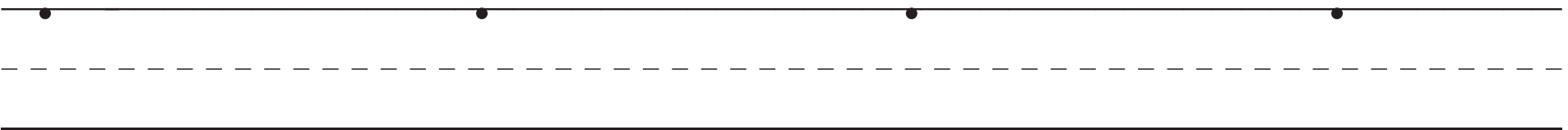

Stroke description to guide letter formation at home:

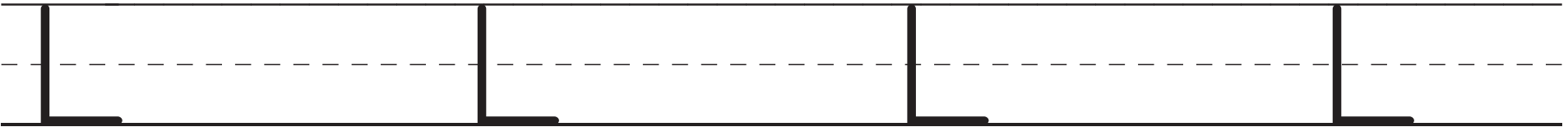
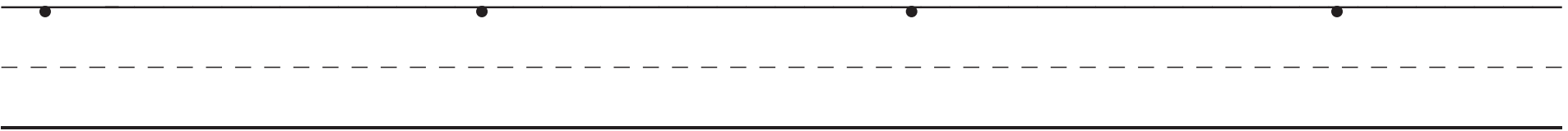
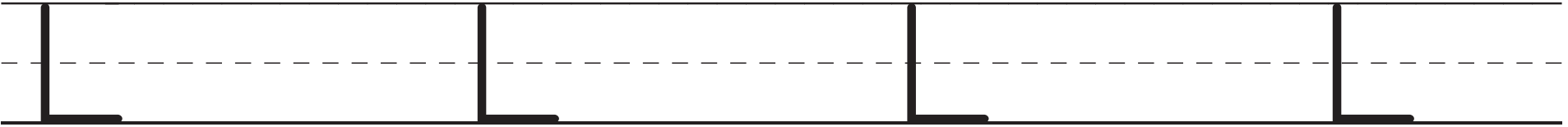
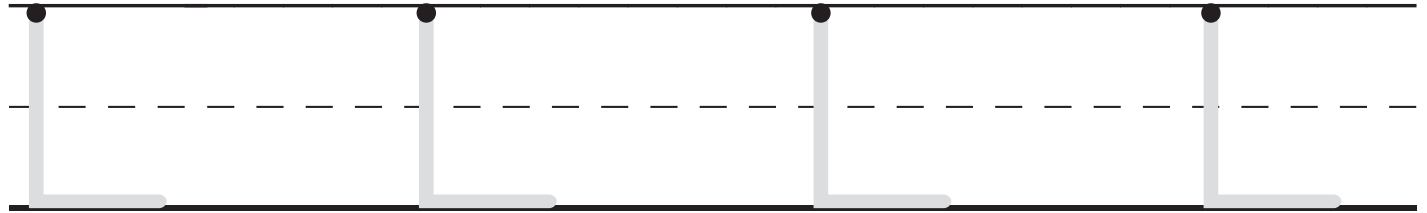
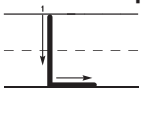

1. Pull down straight. Slide right.

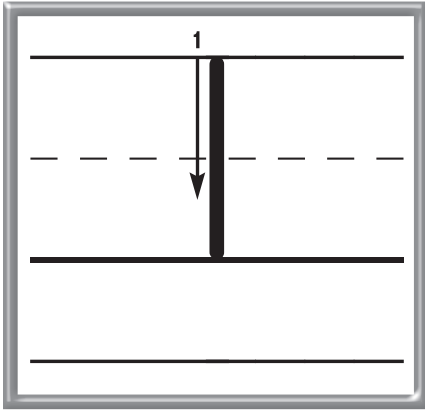

Trace and write the letters.

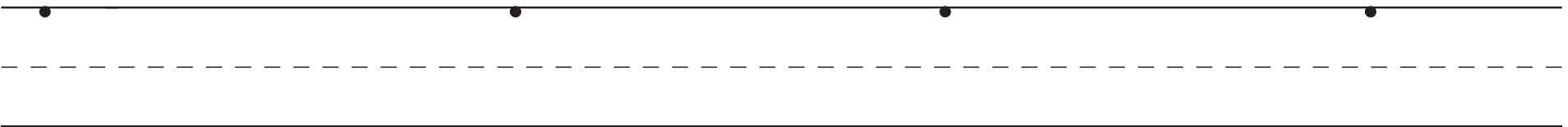
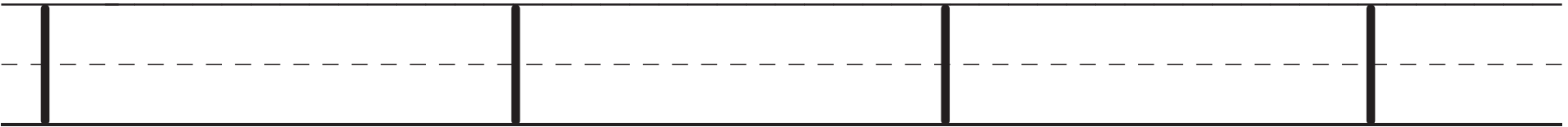
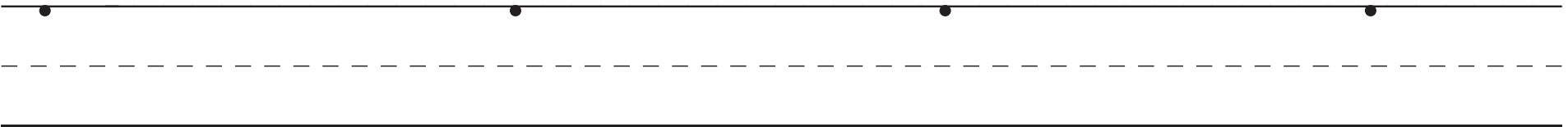
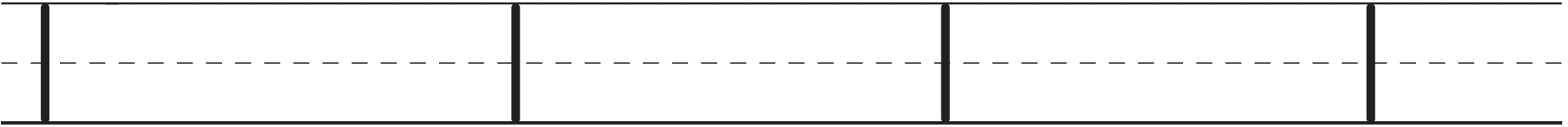
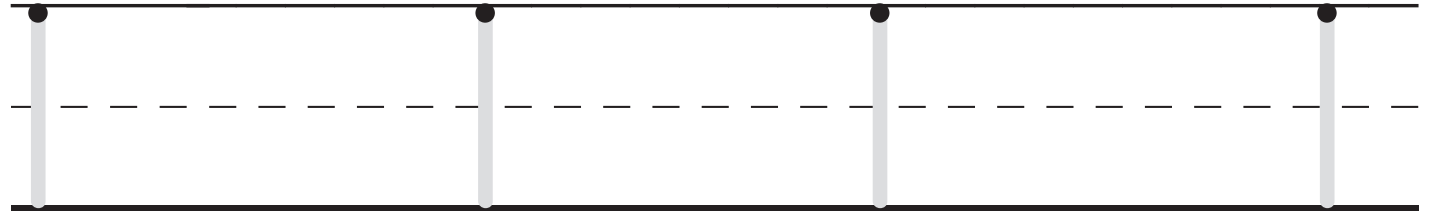

Stroke description to guide letter formation at home:

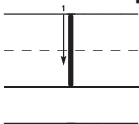

1. Pull down straight.

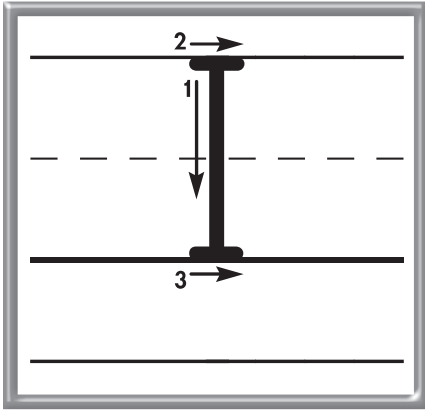

Trace and write the letters.

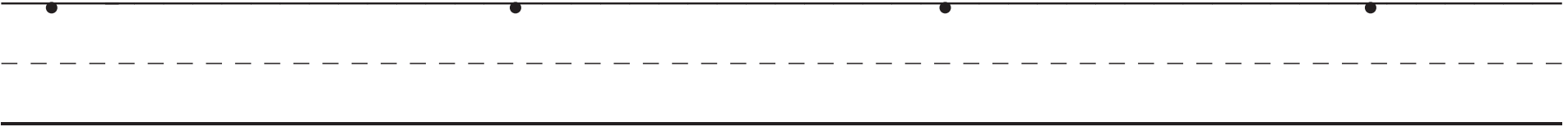
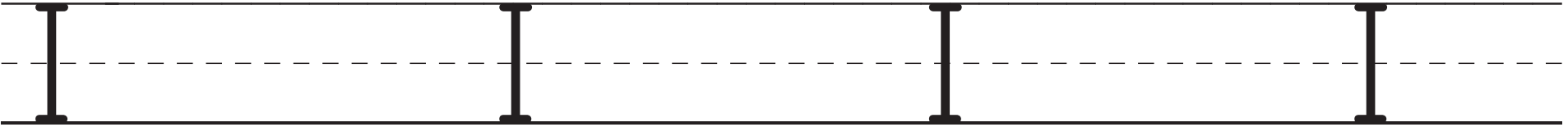
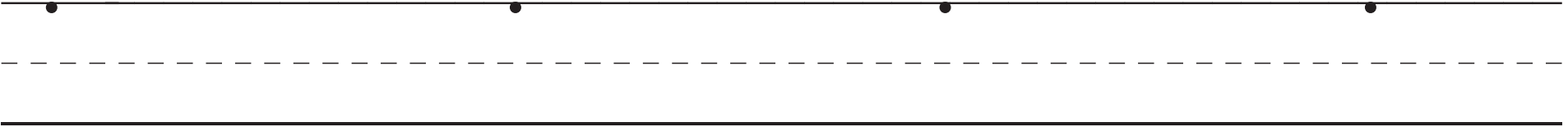
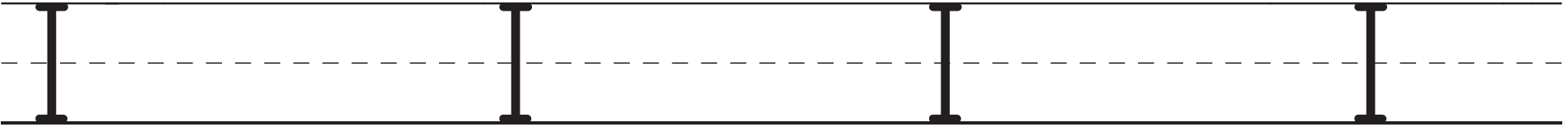
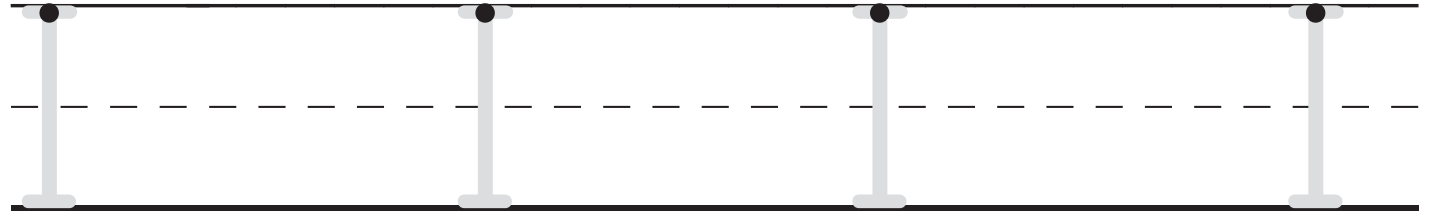

Stroke description to guide letter formation at home:

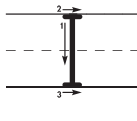
- 
1. Pull down straight. Lift.
 2. Slide right. Lift.
 3. Slide right.

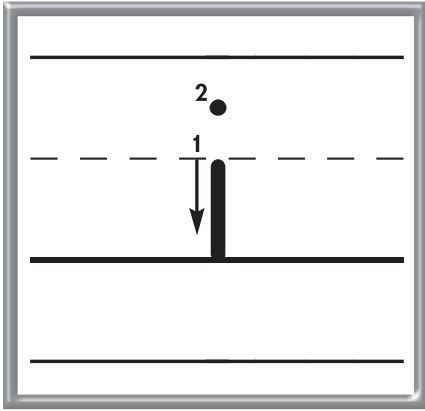

Trace and write the letters.

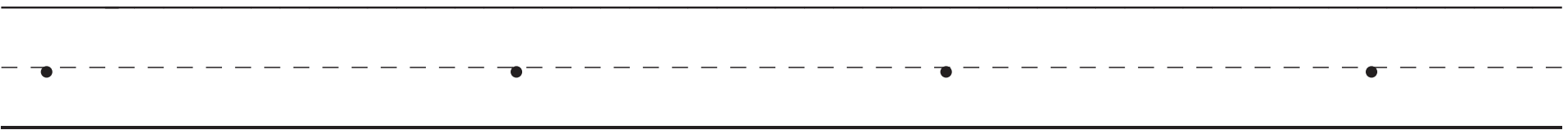
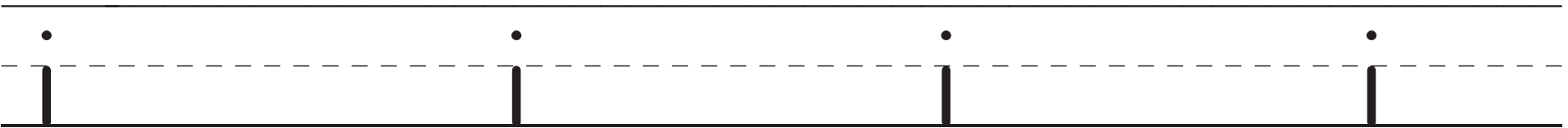
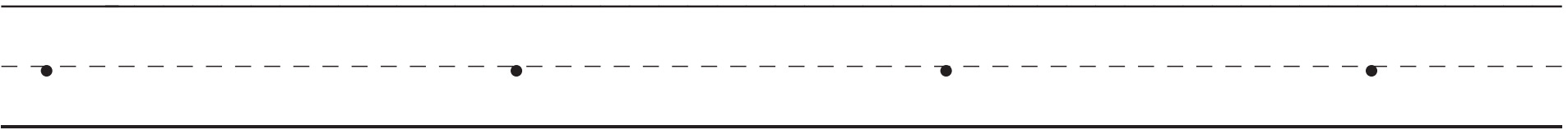
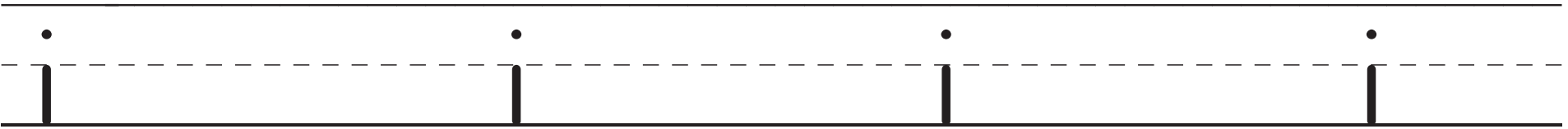
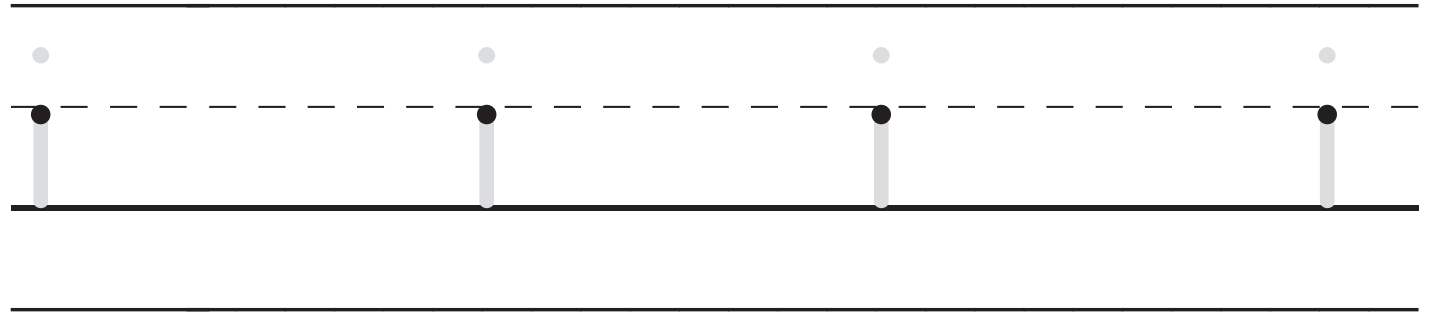

Stroke description to guide letter formation at home:

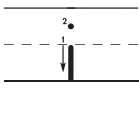

1. Pull down straight. Lift.
2. Dot.

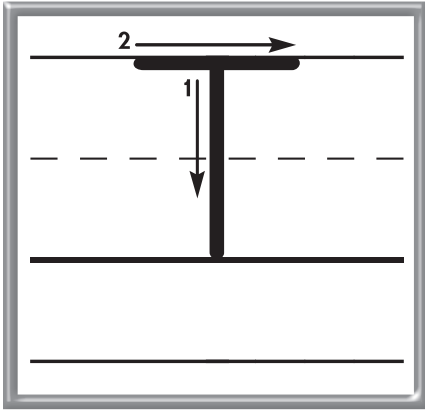

Trace and write the letters.

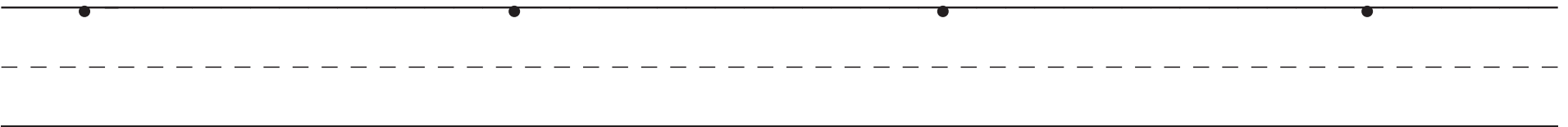
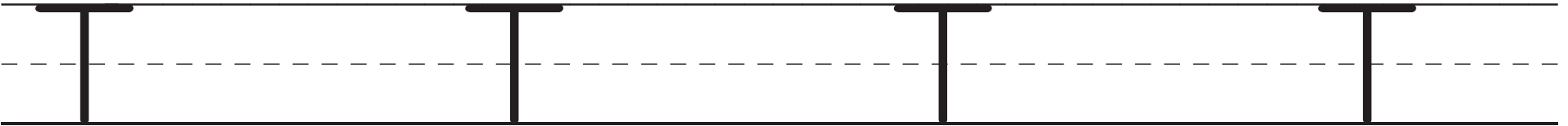
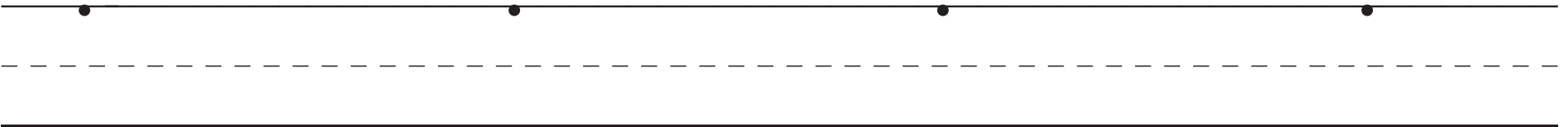
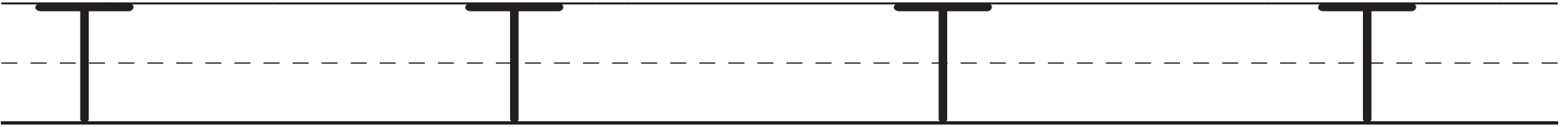
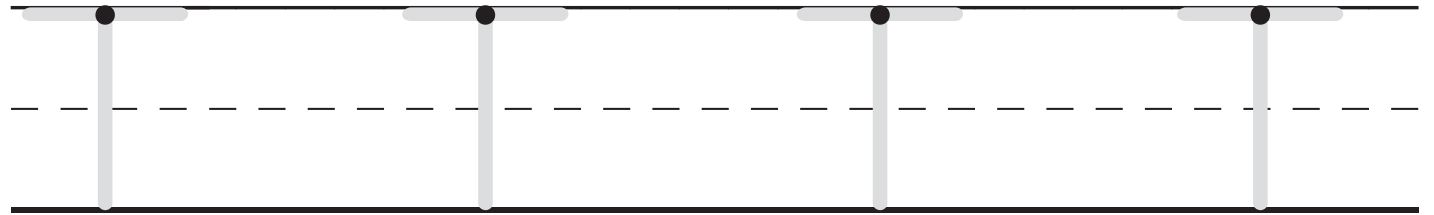

Stroke description to guide letter formation at home:

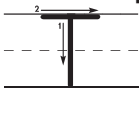

1. Pull down straight. Lift.
2. Slide right.

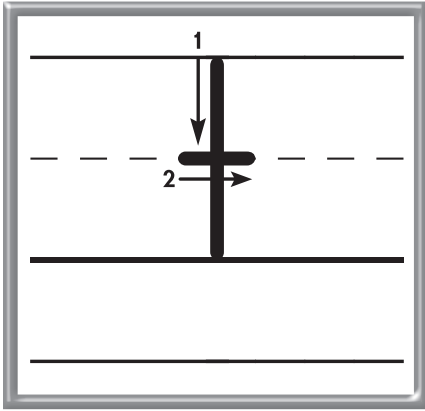

Trace and write the letters.

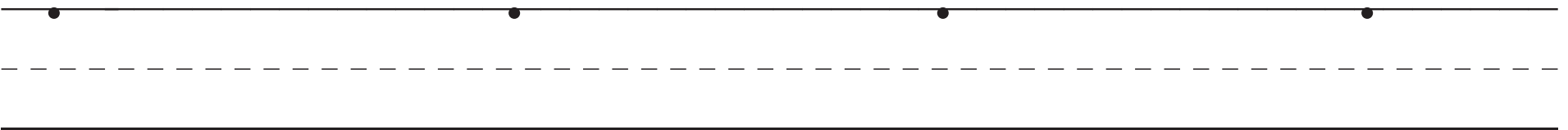
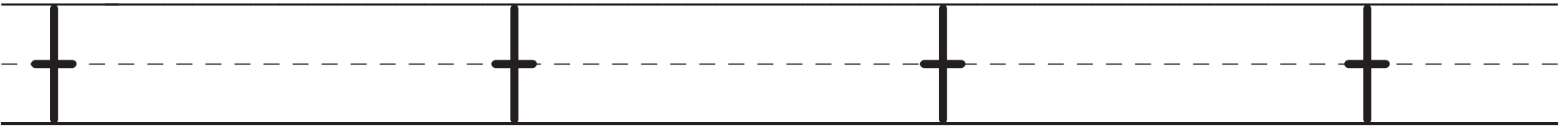
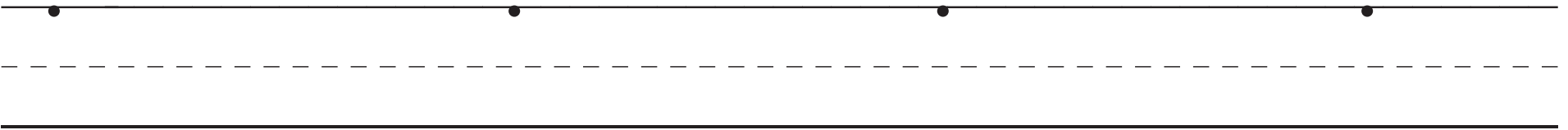
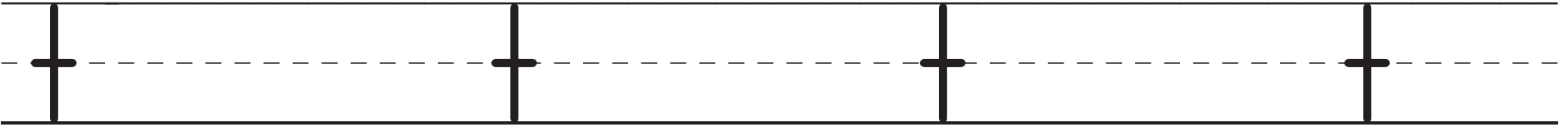
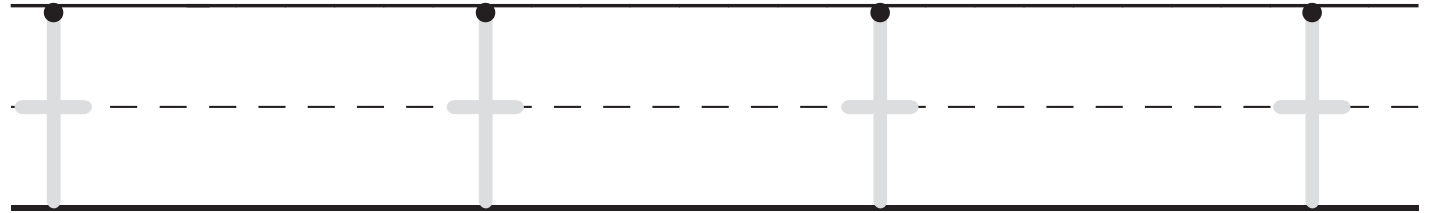

Stroke description to guide letter formation at home:

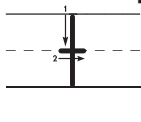

1. Pull down straight. Lift.
2. Slide right.



Note to Families: In handwriting, we have been writing the letters **L** and **I**. Use the stroke descriptions below to review the formation of these letters with your

child. Then spend a few moments completing the following activity together. For additional practice, have your child trace the letters **L** and **I** in the air.

Trace the shaded letters in the picture. Color the picture.

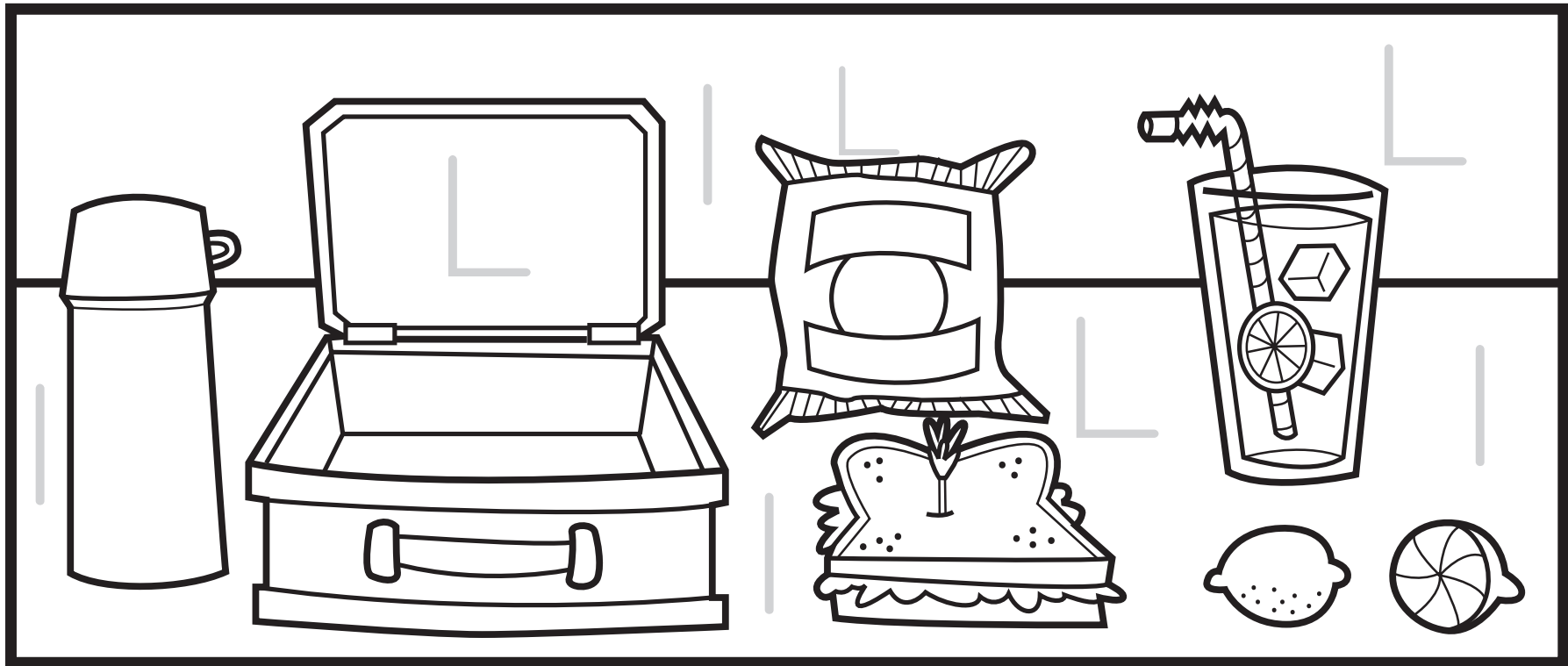

Stroke
Descriptions

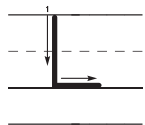

l. Pull down straight. Slide right.

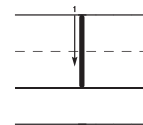

l. Pull down straight.



Note to Families: In handwriting, we have been writing the letters **I** and **i**. Use the stroke descriptions below to review the formation of these letters with your child. Then spend a few moments completing the

following activity together. For additional practice, have your child place the letter cards on items at home that begin with **I** or **i**.

Cut out the letter cards. Make textured letters by attaching dry noodles, sand, or glitter with glue. Trace the letters with your finger, following the correct stroke sequence.

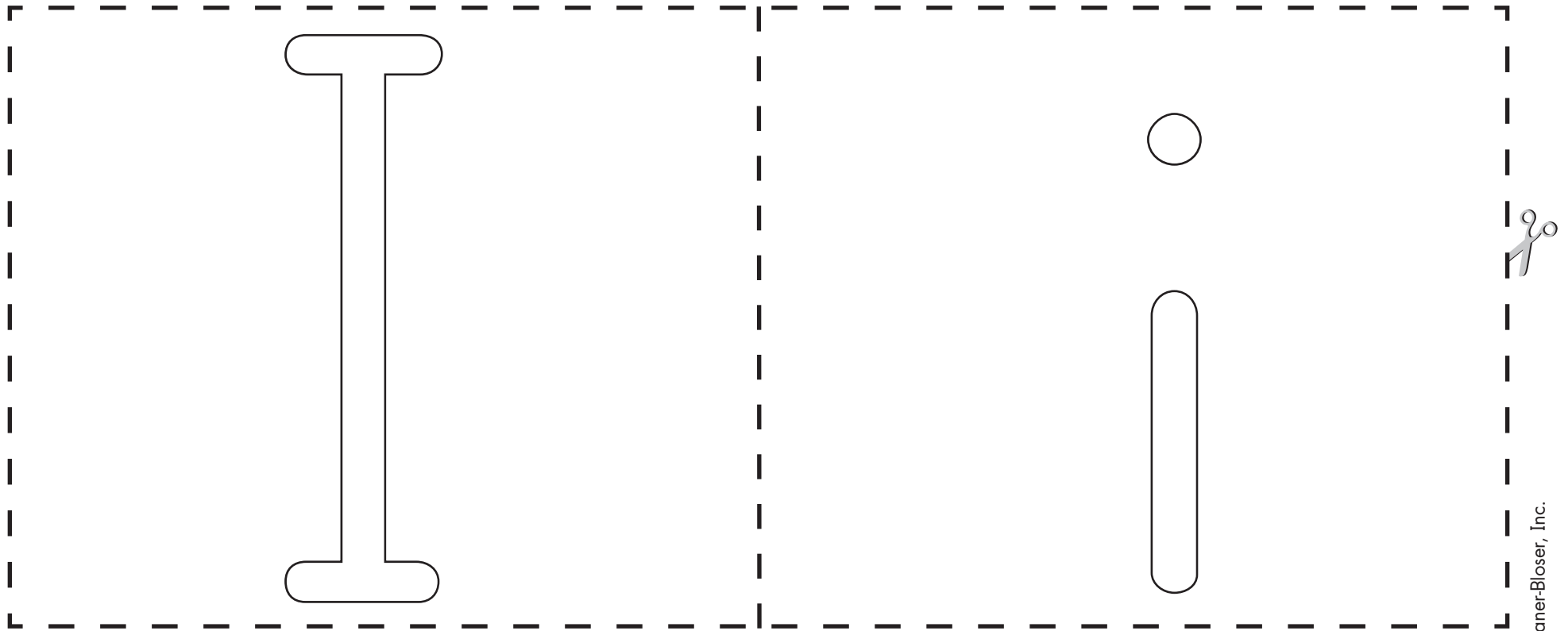

Stroke Descriptions

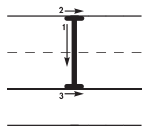

1. Pull down straight. Lift.
2. Slide right. Lift.
3. Slide right.

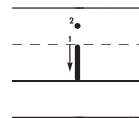

1. Pull down straight. Lift.
2. Dot.



Note to Families: In handwriting, we have been writing the letters **T** and **t**. Use the stroke descriptions below to review the formation of these letters with your

child. Then spend a few moments completing the following activity together. For additional practice, have your child use craft sticks to make **T** and **t**.

Trace the shaded letters in the picture. Color the picture.

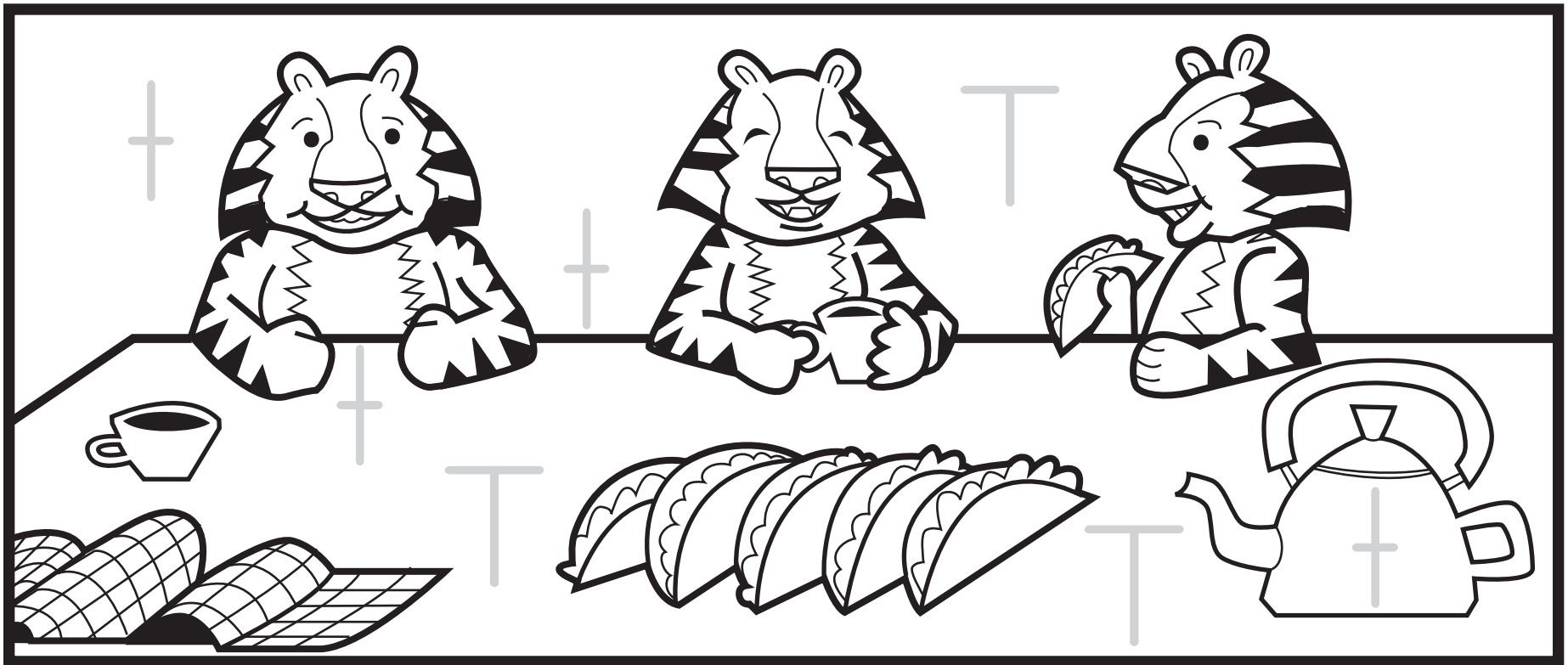

Stroke
Descriptions

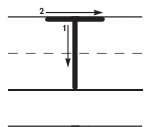

1. Pull down straight. Liff.
2. Slide right.

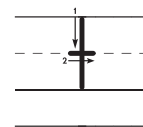

1. Pull down straight. Liff.
2. Slide right.